

Amantii

ELECTRIC FIREPLACE

www.amantii.com

INSTALLATION AND OPERATION INSTRUCTIONS FOR

TRD-26 BESPOKE	BS2000026-1/EU4
TRD-30 BESPOKE	BS2000030-1/EU4
TRD-33 BESPOKE	BS2000033-1/EU4
TRD-38 BESPOKE	BS2000038-1/EU4
TRD-44 BESPOKE	BS2000044-1/EU4
TRD-48 BESPOKE	BS2000048-1/EU4

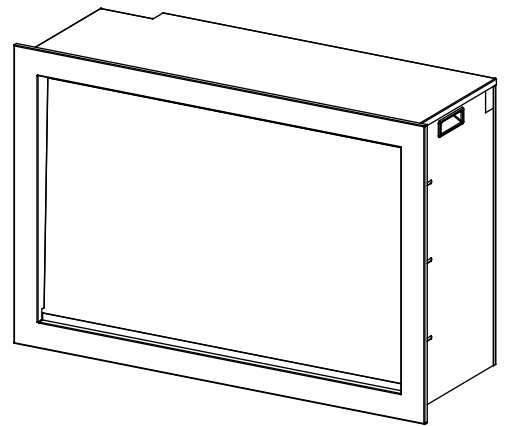

SAFETY INFORMATION

WARNING

if the information in these instructions are not followed exactly, a fire or explosion may result causing property damage, personal injury or loss of life.

Do not store or use gasoline or other flammable vapors and liquids in the vicinity of this or any other.



**INSTALLER: LEAVE THIS MANUAL WITH THE APPLIANCE.
CONSUMER: RETAIN THIS MANUAL FOR FUTURE REFERENCE.**



WARNING: This product can expose you to chemicals including lead in the wiring, which is [are] known to the State of California to cause birth defects of other reproductive harm. For more information visit: www.p65warnings.ca.gov

Please read and carefully follow all of the instruction found in this manual. Please pay special attention to the safety instructions provided in this manual. The instructions included here will assure that you have many years of dependable and enjoyable service from your Amantii Electric Fireplace.

IMPORTANT INSTRUCTIONS.....	03
CAUTIONS.....	04
PLUG INSTALLATION.....	05
UNPACKING AND TESTING APPLIANCE.....	05
LOCATING THE FIREPLACE.....	05
PRODUCT SPECIFICATION.....	06
INSTALLATION- BUILT-IN.....	08
INSTALLING THE DECORATIVE MEDIA.....	10
HARDWIRE INSTALLATION.....	11
MANUAL OPERATION.....	12
REMOTE CONTROL OPERATION.....	13
ENERGY SAVING FUNCTION.....	15
TROUBLE SHOOTING.....	16
MAINTENANCE INSTRUCTIONS.....	16
ENVIRONMENT.....	16
REPLACEMENT PARTS.....	17
EXPLODED VIEW.....	18
ELECTRIC FIREPLACE WARRANTY.....	19

IMPORTANT INSTRUCTIONS

Please read the following instructions carefully before using the appliance.

Caution - Fire, electric shock, physical injury and material damage hazards:

To use the appliance, always follow the instructions for assembly, use and maintenance as well as usage cautions:

1. Carefully read and retain these instructions.
2. Before connecting the appliance, be sure that the mains voltage available matches that specified on the rating plate.
3. Do not use the appliance for other than its intended use. For domestic indoor use only.
4. There may be trace of odour during the first few minutes of initial use. This is normal and will quickly disappear.
5. The heater is hot when in use. To avoid burns, do not let bare skin touch any hot surface.
6. Keep combustible material such as furniture, cushions, bedding, paper, clothes, curtains etc. at least 1m away from the heater.
7. Do not use the heater in areas where flammable liquids are stored or where flammable fumes may be present.
8. Do not cover or obstruct any of the heat outlet grilles or the air intake openings of the heater.
9. Do not use the heater in the rooms with explosive gas or while using inflammable solvents, varnish or glue.
10. Keep the heater clean. Do not allow any objects to enter any ventilation or exhaust opening as this may cause electric shock, or fire or damage to the heater.
11. Always unplug or disconnect the appliance from the mains power supply when not in use or when moving or cleaning it. Do not pull the cord to unplug the heater.
12. Do not immerse the cord, plug or any part of the appliance in water or any other liquid.
13. Do not attempt to repair, disassemble or modify the appliance. There are no user-serviceable parts inside.
14. The heater must not be located immediately below a socket-outlet.
15. Do not use this heater in the immediate surroundings of a bath, a shower or a swimming pool.
16. CAUTION: In order to avoid a hazard due to inadvertent resetting of the thermal cutout, this appliance must not be supplied through an external switching device, such as a timer, or connected to a circuit that is regularly switched on and off by the utility.
17. Do not use this heater with a programmer, timer, separate remote-control system or any other device that switches the heater on automatically, since a fire risk exists if the heater is covered or positioned incorrectly.
18. WARNING: In order to avoid overheating, do not cover the heater.
19. WARNING! – DO NOT COVER THIS APPLIANCE WITH ITEMS SUCH AS CLOTHING, BLANKETS OR PLACE NEXT TO CURTAINS OR NET/BLINDS.
20. If the supply cord is damaged, it must be replaced by the manufacturer, its service agent or similarly qualified persons in order to avoid a hazard.
21. Do not use this heater in small rooms when they are occupied by persons not capable of leaving the room on their own, unless constant supervision is provided.
22. If the glass is damaged, do not use the heater in order to avoid a hazard.
23. Children of less than 3 years should be kept away from unless continuously supervised.
24. Children aged from 3 years and less than 8 years shall only switch on/off the appliance provided that it has been placed or installed in its intended normal operating position and they have been given supervision or instruction concerning use of the appliance in a safe way and understand the hazards involved, Children aged from 3 years and less than 8 years shall not plug in, regulate and clean the appliance or perform user maintenance.
25. CAUTION Some parts of this product can become very hot and cause burns. Particular attention has to be given where children and vulnerable people are present.
26. This appliance can be used by children aged from 8 years and above and persons with reduced physical, sensory or mental capabilities or lack of experience and knowledge if they have been given supervision or instruction concerning use of the appliance in a safe way and understand the hazards involved. Children shall not play with the appliance. Cleaning and user maintenance shall not be made by children without supervision.
27. The heater may emit a slight, harmless odour and smoke when first used. This odour and smoke is normal and it is caused by the initial heating of internal heater parts and will not occur again.
28. DO NOT plug into an extension lead/cable or plug adaptor.
29. DO NOT cut off the plug and hardwire directly into the mains or via a fused fixed spur.
30. For details about installing the fireplace, please refer to "Installation" section.

CAUTIONS

Do's	Always install the heater in accordance with this guide. If in doubt obtain expert advice.
	Always make sure the electrical socket is accessible and located adjacent to, but not above the heater.
	Always disconnect the heater from the electrical supply before moving it, or carrying out cleaning, maintenance.
	Always make sure the heater is firmly secured to prevent it from being tipped over.
	Always use a fireguard when young children and infirm persons can come into contact with the heater.
Don'ts	Never leave children unsupervised in a room where the heater is ON and unguarded.
	Never obstruct or cover the fan outlet or force items into heater openings.
	Never use aerosols or steam cleaners on or around the heater.
	Never route the main supply cable under carpet etc.
	Never install the heater close to curtains or combustible materials.
	Never use the heater to dry clothes etc.
	Never sit or stand on the heater.

PLUG INSTALLATION

Your power cord will come separate from the unit, please locate it when unpacking your fireplace. The plug contained inside the box is predetermined at the factory and according to orders placed by authorized dealers.

Available are UK, European, Swiss & Australian plugs. Should you require any of these options please contact your dealer for purchase. You will be required to give them the correct part number as listed below.



UK plug
10103060E

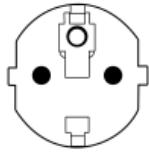

European plug
10103030E

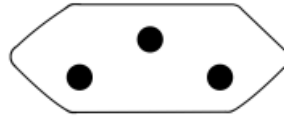

Swiss plug
10103109E

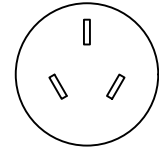

Australian plug
10103087F

Hold the male plug and insert it into the female receptacle. The receptacle is located on the left side of the fireplace. Please make sure the plugs are firmly connected.

UNPACKING AND TESTING APPLIANCE

Carefully remove the appliance from the box.

Prior to installing the appliance, test to make sure the appliance operates properly by plugging the power supply cord into a 240 Volt grounded outlet.

Test all aspects of its operation (manual switches, remote and heater) to make sure all components are operating correctly.

NOTE: There may be trace of odor during the first few minutes of initial use. This is harmless, normal and will never occur again.

LOCATING THE FIREPLACE

Plan where to locate and frame the fireplace. This will save time and money later when you install the fireplace. Before installation consider the following:

1. Where the fireplace is located must allow for wall and ceiling clearances.
2. Consider a location where the fireplace screen will not be exposed to direct sunlight from windows or doors.
3. A 15A / (10A for AUS), 240 Volt, 50-60 Hz branch circuit with proper ground must be available at the location. Preferably a dedicated branch circuit should be provided to avoid circuit breakers to trip or fuses to blow.

PRODUCT SPECIFICATION

product model	BS2000026-1/EU4 (TRD-26 BESPOKE)	BS2000030-1/EU4 (TRD-30 BESPOKE)	BS2000033-1/EU4 (TRD-33 BESPOKE)
Voltage	220-240V AC 50Hz		
Watts	1700-2000W		
Cord Length	L=70.9" L=180 cm		
Appliance size (W x D x H)	25 1/4"x 11 5/8" x 16 1/8" 64.2 x 29.6 x 41.1 cm	29 3/8"x 11 5/8" x 18 1/2" 74.7 x 29.6 x 47.1 cm	31 3/4"x 11 5/8" x 21 5/8" 80.7 x 29.6 x 55.1 cm
Glass Viewing (W1 x H1)	23 3/8" x 13 1/4" 59.4 x 33.5 cm	27 1/2" x 15 1/2" 69.9 x 39.5 cm	29 7/8" x 18 3/4" 75.9 x 47.5 cm
Frame size (W2 x H2)	27 3/8" x 17 1/8" 69.4 x 43.5 cm	31 1/2" x 19 1/2" 79.9 x 49.5 cm	33 7/8" x 22 5/8" 85.9 x 57.5 cm
Wall Opening Size (W3 x D3 x H3)	26 1/4" x 12" x 16 3/8" 66.7 x 30.6 x 41.5 cm	30 3/8" x 12" x 18 3/4" 77.2 x 30.6 x 47.5 cm	32 3/4" x 12" x 21 7/8" 83.2 x 30.6 x 55.5 cm

NOTE: The wall opening size is suitable for fireplace without adjustable leveling feet.

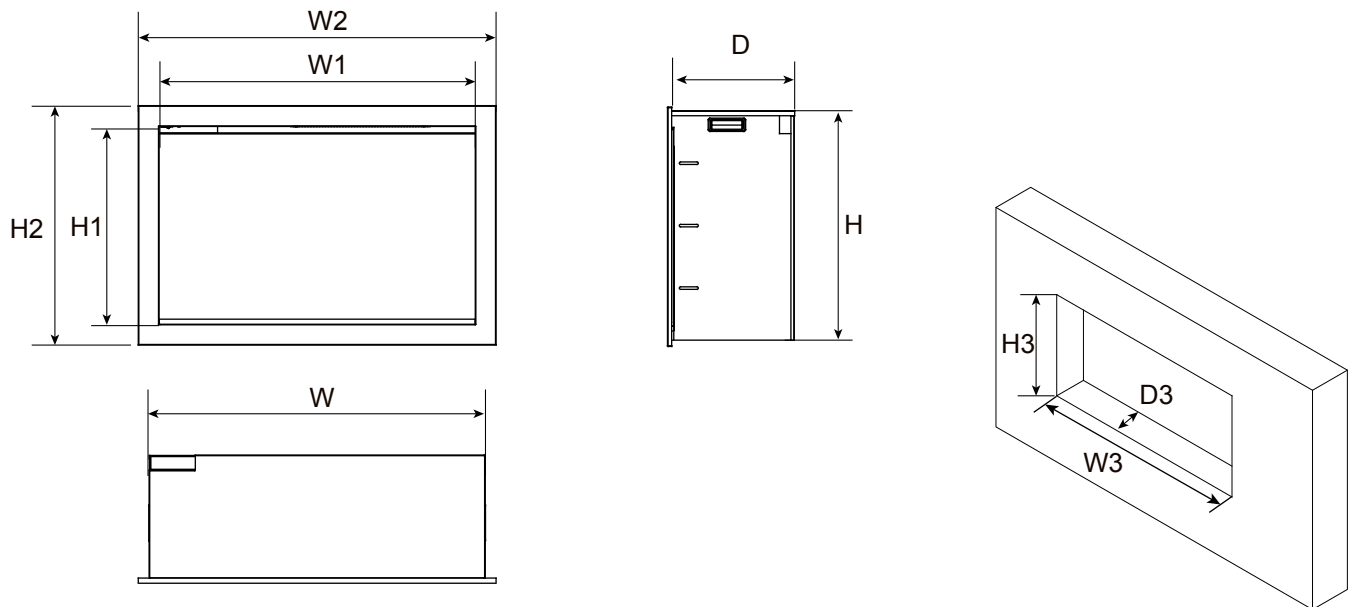

product model	BS2000038-1/EU4 (TRD-38 BESPOKE)	BS2000044-1/EU4 (TRD-44 BESPOKE)	BS2000048-1/EU4 (TRD-48 BESPOKE)
Voltage	220-240V AC 50Hz		
Watts	1700-2000W		
Cord Length	L=70.9" L=180 cm		
Appliance size (W x D x H)	37 1/8"x 12 5/8" x 26 5/8" 94.4 x 32.1 x 67.7 cm	43 1/4"x 14" x 31 1/8" 109.8 x 35.6 x 78.9 cm	47 1/4"x 14" x 41 1/8" 120 x 35.6 x 104.3 cm
Glass Viewing (W1 x H1)	35 1/4" x 23 5/8" 89.6 x 60.1 cm	41 3/8" x 28 1/8" 105 x 71.3 cm	45 3/8" x 38 1/8" 115.2 x 96.7 cm
Frame size (W2 x H2)	39 1/4" x 27 5/8" 99.6 x 70.1 cm	45 1/4" x 32" 115 x 81.3 cm	49 1/4" x 42" 125.2 x 106.7 cm
Wall Opening Size (W3 x D3 x H3)	38 1/8" x 13" x 26 7/8" 96.9 x 33.1 x 68.1 cm	44 1/4" x 14 3/8" x 31 1/4" 112.3 x 36.6 x 79.3cm	48 1/4" x 14 3/8" x 41 1/4" 122.5 x 36.6 x 104.8 cm

NOTE: The wall opening size is suitable for fireplace without adjustable leveling feet.

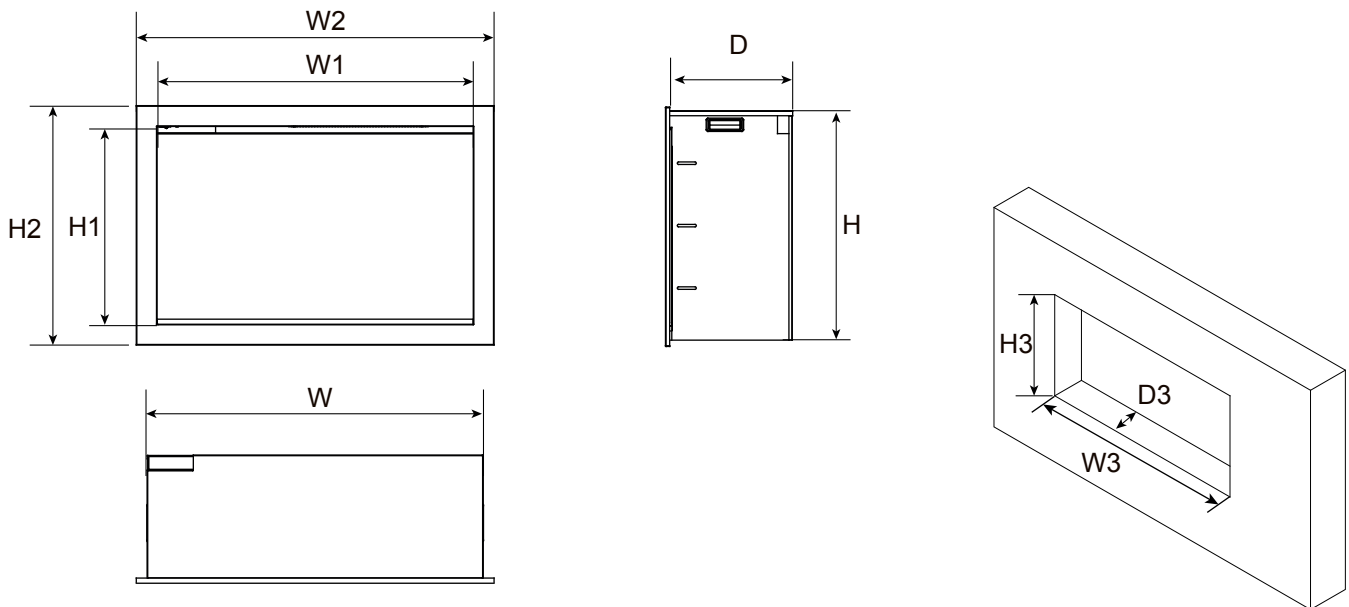

INSTALLATION- BUILT-IN

NOTE: Due to the many different materials used to build walls, it is highly recommended that you consult your local builder before you install this appliance on a wall.

Preparation

1. Select a location that is not prone to moisture and is located at least 0.91m or 3 feet away from combustible materials such as curtains, drapes, furniture, bedding, paper, etc.
2. Mark the desired location on the floor and store the appliance in a safe, dry and dust free place.
3. Prepare a wall with a framed opening to accommodate the size of your unit. Leave at least 1/4" (6mm) around the edge of the appliance. Any new wiring must be done in compliance with local and national codes and other applicable regulations.

1. Unscrew 4 screws and take off the trim. (NOTE: Keep hold of the front glass as it may fall down automatically when the trim is removed.)

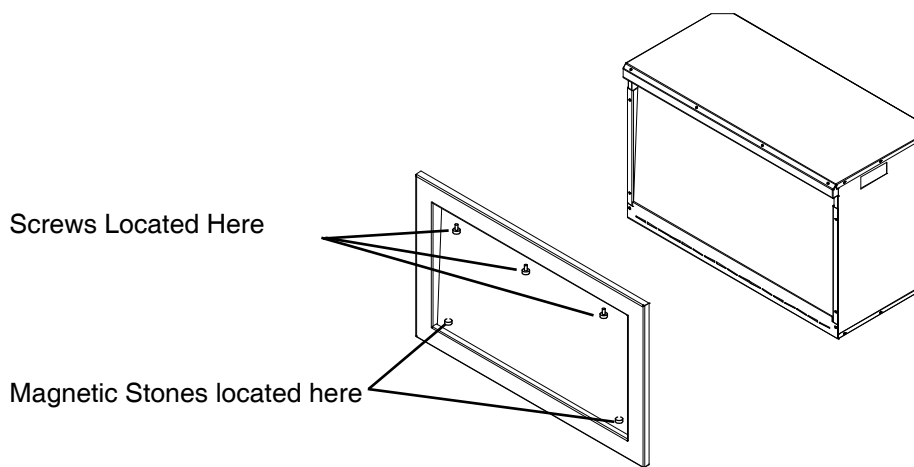

2. Carefully remove the front glass panel once the trim has been removed. Use caution as the glass is now loose.

3. Unscrew the screws located on each side and take off the inner side steel panels.

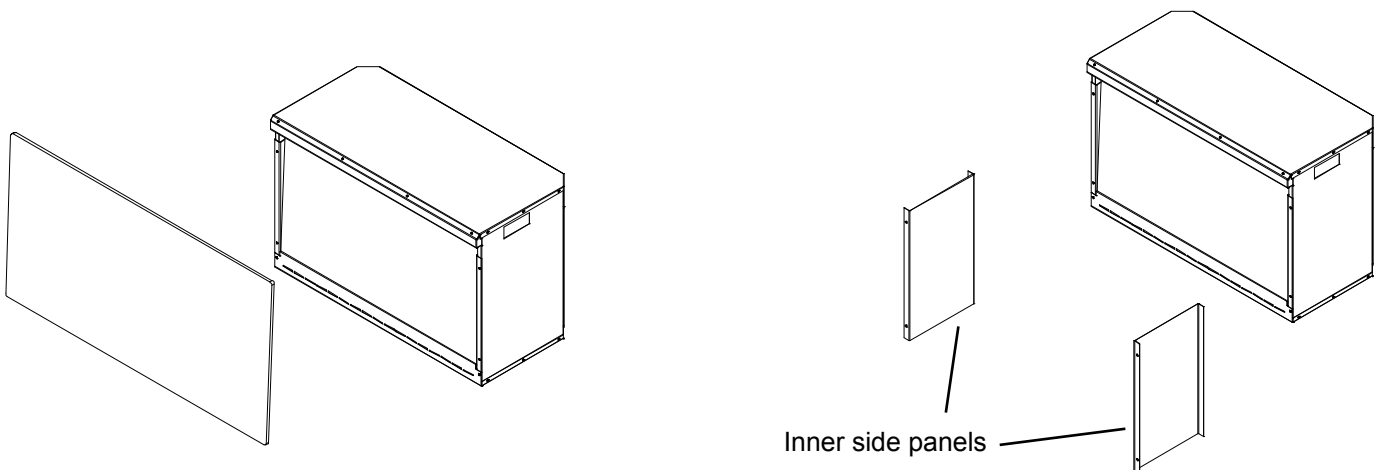

4. Put the trim back onto the appliance and fasten with screws. (NOTE: This step is to make sure that the fireplace fits the wall opening well and there is no gap between the trim and the wall after installation)

5. Put the fireplace into the wall opening and fix it to the wall by screwing 2 screws each side.

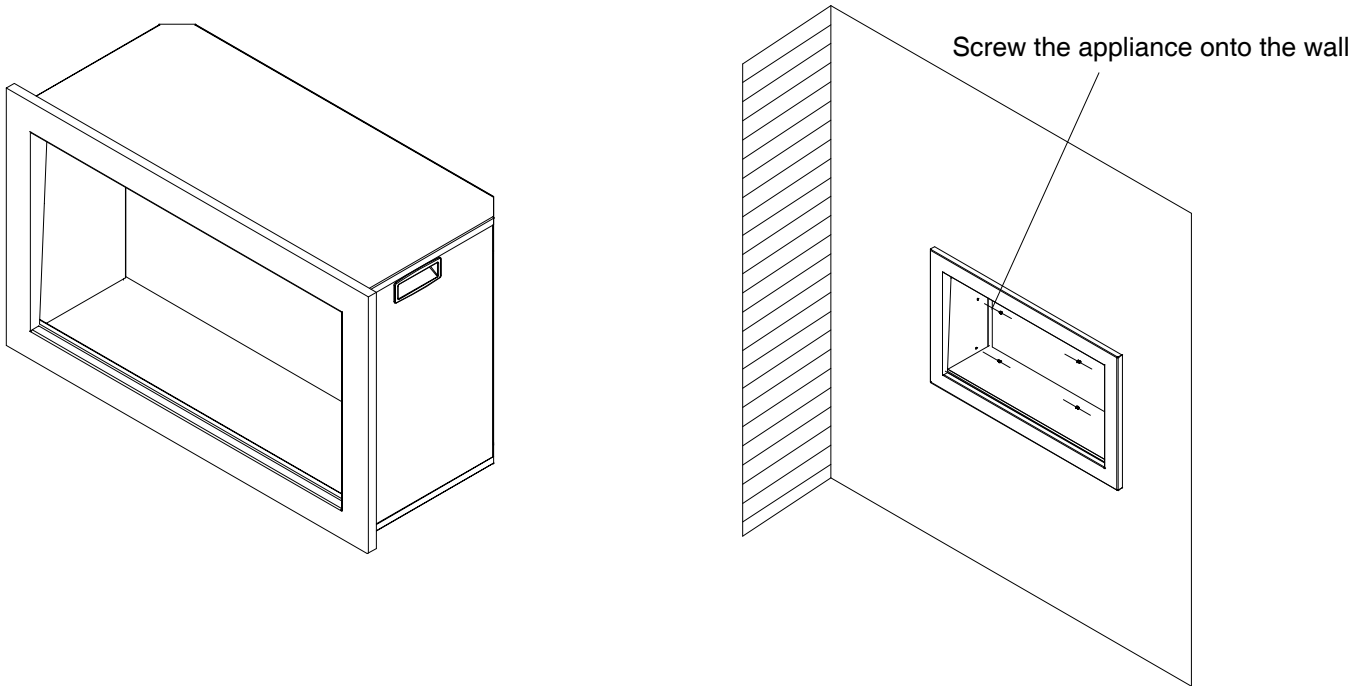

6. Remove the trim following STEP 1. Screw back the inner side steel panels.

7. Insert the front glass panel back in place after the media installation has been completed.

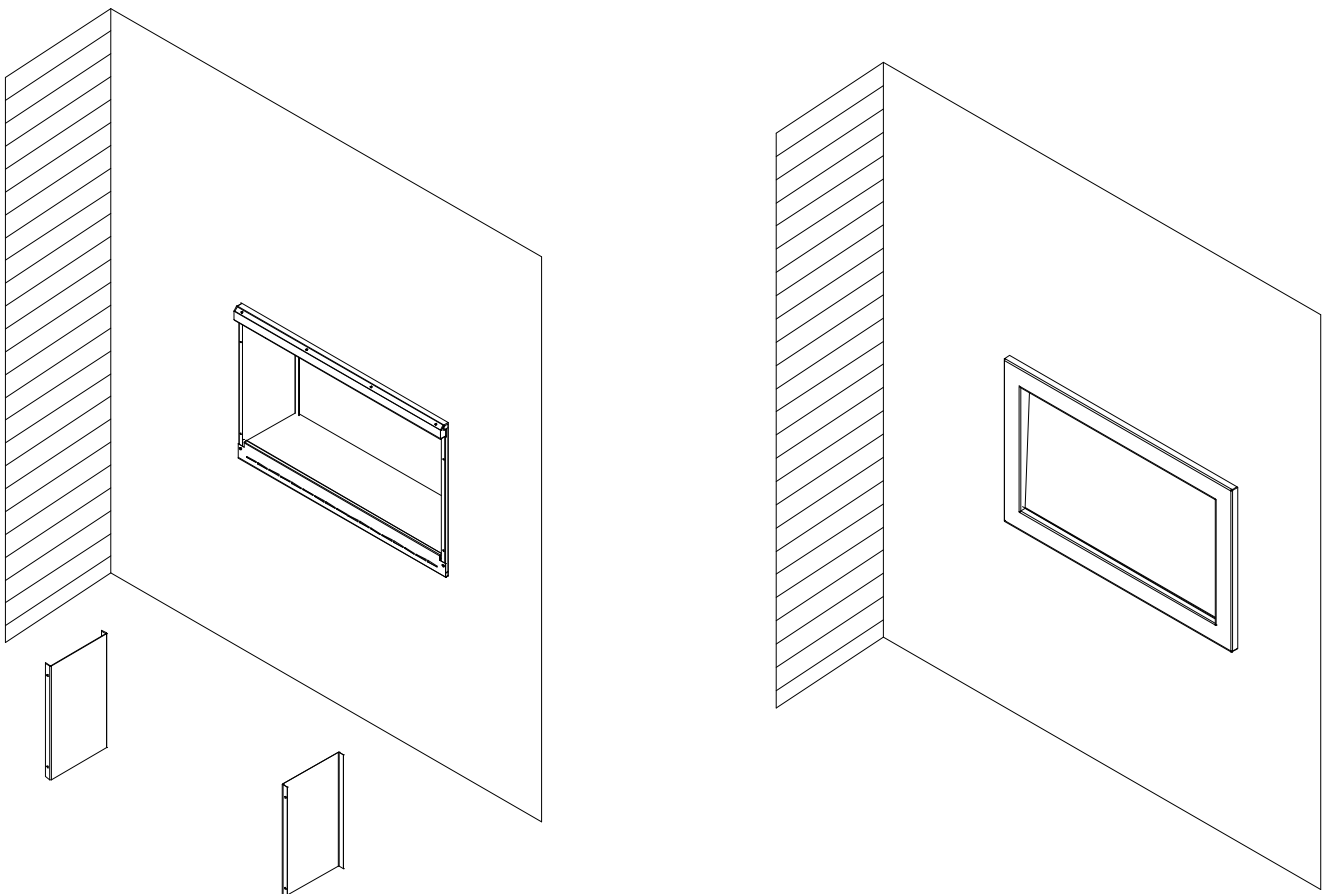

INSTALLING THE DECORATIVE MEDIA

1. Unscrew 4 screws and take off the trim. (NOTE: Keep hold of the front glass as it may fall down automatically when the trim is removed.)

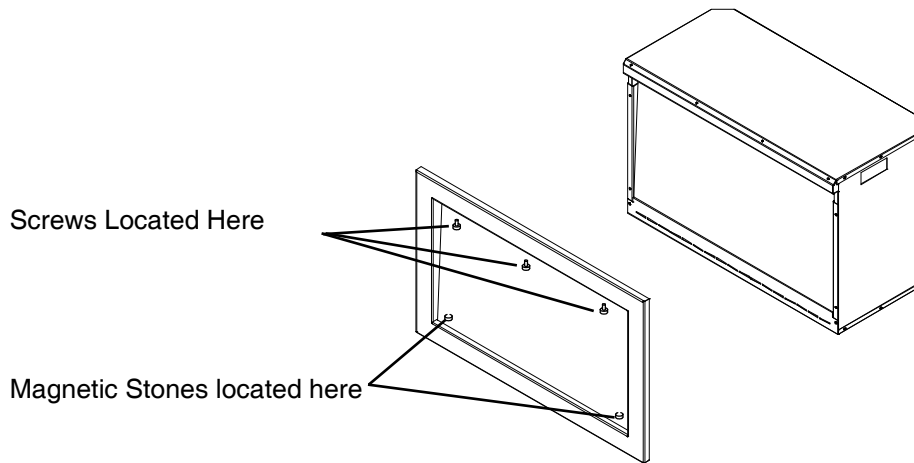

2. Carefully remove the front glass panel once the trim has been removed. Use caution as the glass is now loose.

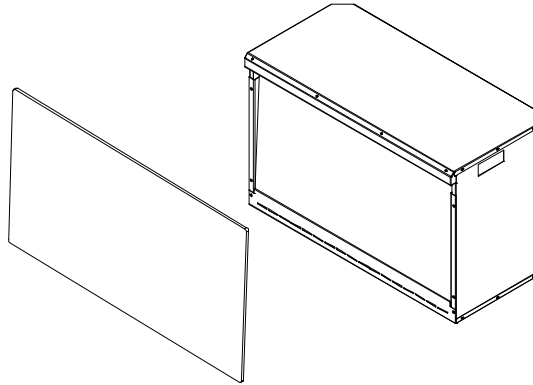

3. Pour the fire glass media into the tray. Feel free to use any combination of the fire glass media that you find most appealing. Insert the front glass panel back in place after the media installation has been completed.

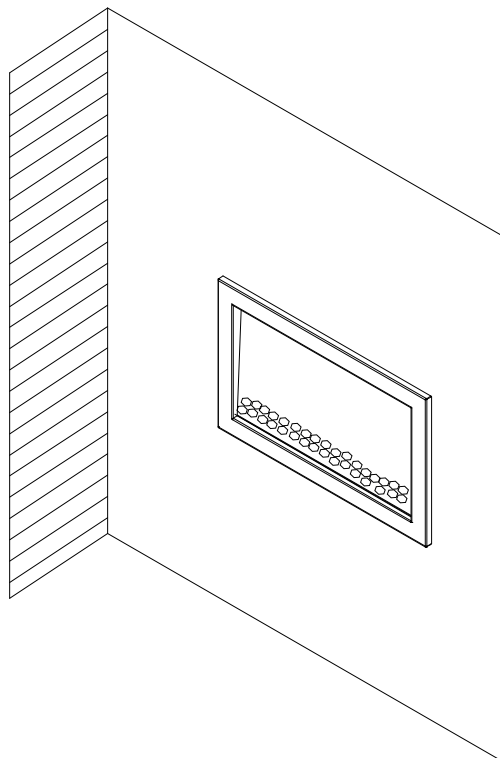

HARDWIRE INSTALLATION

Turn off the appliance completely and let cool before servicing. Only a qualified service person should service and repair this electric appliance.

If it is necessary to hardwire this appliance, a qualified electrician must remove the cord connection, and wire the appliance directly to the house hold wiring.

This appliance must be electrically connected and grounded in accordance with local codes, if hardwired.

1. Test the unit before removing the cord.

Remove the cover plate from the back top right corner of the appliance by removing the four screws, as shown below. Unscrew and remove power cord.

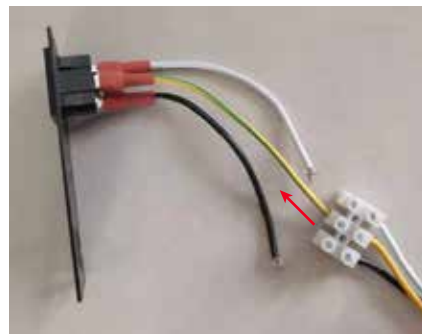

2. Attach the wiring to the junction block. Please make sure the live wire goes into the "L", the neutral wire into "N" and the ground wire into "G".

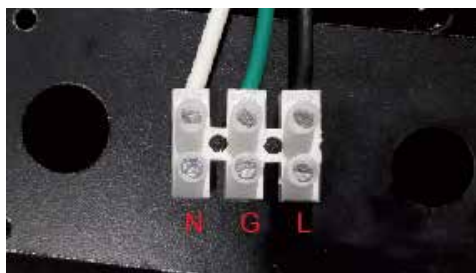

3. Return the cover plate to the back top right corner and screw the four screws back in to fasten the plate.





MANUAL OPERATION

The fireplace operates either by the touch panel located on the left front top side of the fireplace or by supplied remote control.

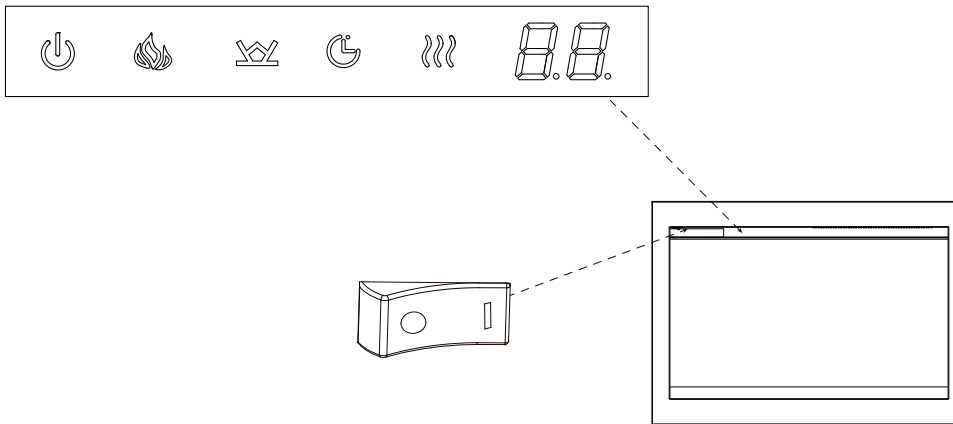

Ensure that the ON / OFF Power Switch on the fireplace is in the ON position.





Touch the control panel once to “wakes up” the controls. This will cause the controls to light up. At this time, you can press the power button to turn on fireplace

1. Press “  ” to turn on and off the fireplace.
2. Press “  ” to adjust the flame brightness. There are 6 brightness levels (L6-L1) and an off(OFF) position. Each time the flame button is pressed, the brightness of the flame decrease.

Press the flame button more than 5 seconds, the timer indicator light on and will rapidly blinks, at this time, you can use the TuyaSmart APP to connect to the fireplace.

3. Press “  ” to adjust the ember bed brightness. There are 7 brightness levels (d8-d2), dynamic condition(d1) ,and the OFF(OFF) setting you can cycle through. Each time the ember bed button is pressed, the brightness of the ember bed decrease.
4. Press “  ” for the first time to display the current timing, press the button again to clear the current timing. If the timing in off position, the second press will show 30. Multiple times to set operating duration to OF, 30 min, 1h, 2h, 3h, 4h, 5h, 6h, 7h, 8h.

Press and hold the “  ” for 5 seconds to turn on the sound.

5. Press “  ” for the first time to display the current setting temperature, press the button again to clear the current temperature. If the heater in off position, the second press will show 22 C (72 F). Multiple times to set ambient temperatures at 22 C (72 F), 23 C (74 F), 24 C (76 F), 25 C (78 F), 26 C (80 F), 27 C (82 F), 28 C (83 F), 15 C (59 F), 16 C (60 F), 17 C (62 F), 18 C (64 F), 19 C (66 F), 20 C (68 F), 21 C (70 F).

Temperature unit convert function: When the heater is on, press and hold the “  ” Button for 5 seconds, current temperature unit display will convert to another temperature unit.











NOTE: The heater is turned on by switching on the fan first, then after 5 seconds the heating coil. The heater is turned off by switching off the heating coil first, then after 30 seconds the fan.

REMOTE CONTROL OPERATION

For the remote to function make sure the fireplace is plugged in and the ON / OFF Power Switch on the fireplace is in the ON position and the remote has batteries.

Important: When operating the remote make sure you point the remote to the center of the fireplace. Each time you press the button, there will be a beep tone emitted.



Setting the current time of the remote control

You must press the  key to open the remote control and press the  key to enter the setting current time state. When one of the "Sun" "Mon" "Tue" "Wed" "Thu" "Fri" "Sat" date is flashing, you can press the  or  key to select the current day of the week, and press the  key to confirm and enter hour setting. When the digital tube of time hour flashes, press the  or  key to set the current time and press the  key to confirm and enter minute setting. When the digital tube of time minute flashes, press the  or  key to set the current time and press the  key to confirm.



This Power Button turns the fireplace on and off. It has a memory function, press the power button once to turn power on. Pressing the power button again will turn the power off.



The Timer Button has adjustable setting at range from 30 minutes to 8 hours. As shown the following: 0:30- 1:00- 1:30- 2:00- 2:30- 3:00- 3:30- 4:00- 4:30- 5:00- 5:30- 6:00- 6:30- 7:00-7 :30- 8:00. Once you have set the timer, The  icon will be displayed on the LCD screen of the remote control. Press this button again, cancel the timing setting, and the  icon disappears.





When the timer is up, it will close all the functions and enter standby mode. In this mode, you should touch the power icon to restart the appliance.







Each time the Heater Button is pressed, the power of the heater will change. As shown the following: H1- H2- AUTO(22 °C)- OFF(no display).





H1 means the fireplace on Low Heat.

H2 means the fireplace on High Heat.

AUTO means fireplace can automatically adjust to the temperature you set. When in AUTO, you can set the desired temperature with  or  keys. You can switch temperature unit between Celsius and Fahrenheit with  or  keys.

 Each time Speed Button is pressed, the speed of the flame will change. Three options are available: Medium-High- Low.





 The Moodlight Button turns the moodlight on and off. When in on position, the display screen of the remote control shows AD 1, when the number “1” flash, you can set the color of moodlight with  or  keys. There are 10 different moodlight colors(AD1-10) and dynamic condition(AD11) to choose from.

 The Ember Bed Button turns the Ember bed light on and off. When in on position, the display screen of the remote control default shows 8 8 8. You can press  or  or  keys to change the corresponding color.

 Each time the Red Button is pressed the brightness of the red color decrease. There are 7 brightness levels (8-2), dynamic level(1) and OFF (no display) settings that can be cycled through. When no number is displayed on the remote control LCD screen then the ember bed color is off.

 Each time the Green Button is pressed the brightness of the green color decrease. There are 7 brightness levels (8-2), dynamic level(1) and OFF (no display) settings that can be cycled through. When no number is displayed on the remote control LCD screen then the ember bed color is off.

 Each time the Blue Button is pressed the brightness of the blue color decrease. There are 7 brightness levels (8-2), dynamic level(1) and OFF (no display) settings that can be cycled through. When no number is displayed on the remote control LCD screen then the ember bed color is off.

 The Flame Button turns the Flame on and off. When in on position, the LCD screen of the remote control default shows 6 6 6. You can press  or  or  key to change the corresponding color.

 Each time the Red Button is pressed the brightness of the red color decrease. There are 6 brightness levels (6-1) and OFF (no display) settings that can be cycled through. When no number is displayed on the remote control LCD screen then the flame color is off.

 Each time the Orange Button is pressed the brightness of the orange color decrease. There are 6 brightness levels (6-1) and OFF (no display) settings that can be cycled through. When no number is displayed on the remote control LCD screen then the flame color is off.











 Each time the Yellow Button is pressed the brightness of the yellow color decrease. There are 6 brightness levels (6-1) and OFF (no display) settings that can be cycled through. When no number is displayed on the remote control LCD screen then the flame color is off.



NOTE: If the flame and ember bed brightness are off before the heating function is turned on, after turning on the heat, the flame and ember bed brightness is slightly light on by default.



7 day timer function





NOTE: Ensure that the current time setting accurate, otherwise the effective time of the 7 day timer function will be different from what you set.



Press the  key once, 7 days from Monday to Sunday will display on the LCD screen of the remote control, press  key within 5 seconds to enter 7 day timer function . When “Sun” is flashing use the  or  key to select the day that you want to set, pressing the  key to confirm. Then “ON” will be displayed on the LCD screen of the remote control, at the same time, the hour on the digital clock flashes, press the  or  key to set the hour and then the minute you want the fireplace to turn on. After setting the start up time, “OFF” will be displayed on the LCD screen. Use the  or  key to set the shutdown time the same as setting the start up time. After setting the shutdown time, “AUTO” will be displayed on the LCD screen of the remote control. The digital temperature flashes, at this time you can set the desired temperature with  or  keys. The fireplace will beep to acknowledge the settings. Now, the 7 day function has been set, the fireplace will save the setting and run automatically.

When the 7 day timer is set, the icon  will be displayed on the LCD screen of the remote control. Press the  key again to cancel the 7 day timer function, the  will disappear.

NOTE: If the 7 day timing and general timing exist at the same time, the shutdown time shall be the earlier time. For example, it is now 6 am on Tuesday, turning on the heaters general timer for 4 hours, will have the shutdown time of 10 am. The previous 7 day shutdown time is 8 am on Tuesday, so today's heater shutdown time is 8 am instead of 10 am.



The Refer Button queries the 7-day timer setting. This will not turn on the timer function but will only show the previous setting. Press the  or  key to query the day of the week. Press the  or  key to query the start up and shutdown time.

Press  key once to enter the query mode, press the  key again to exit query mode.



This button turns the fire crackling sound on and off.

ENERGY SAVING FUNCTION

If the heater detects a drop in temperature caused by an open window or door whilst in heat mode it will shut off the heater followed by flashing the ember bed light. To restart the heater press the any button.

TROUBLE SHOOTING

Fault code	Fault Cause	Solution
E1	The heater overheating	Call after-sales service.
E2	NTC is defective.	Call after-sales service.
E3	The heater not working.	If the vents are dirty or clogged. Unplug the power, clean the dust and debris of the vent area. Wait for 5 minutes, plug in and turn on the heater. If the heater still don't work, please call after-sales service.

Each time the heater button is pressed in the E1 state, one beep tone will be given.

Each time the heater button is pressed in the E2 state, two beeps tone will be given.

Each time the heater button is pressed in the E3 state, three beeps tone will be given.

MAINTENANCE INSTRUCTIONS

- Always remove the plug from the socket-outlet and allow the heater to cool down before cleaning it.
- Wipe the exterior surface of the appliance occasionally with a soft damp cloth (not dripping wet) and dry the exterior surface before operating the heater.



WARNING!

Do not immerse the heater in water.

Do not use any cleaning chemicals such as detergents and abrasives.

Do not allow the interior to get wet as this could create a hazard.

- Light accumulated dust may be removed from the appliance with a soft dry cloth.
- To store away the appliance put it back in to its original packaging and store it in a clean dry place.
- In the event of malfunction do not try to repair the heater yourself as this may result in a fire hazard or electric shock.

NOTE: The blower motor and flame motor are pre-lubricated for a durable period of time and need no further lubrication or maintenance. As the dust particles will accumulate on/in the fireplace, so periodic cleaning/ vacuuming of the fireplace is recommended.

ENVIRONMENT

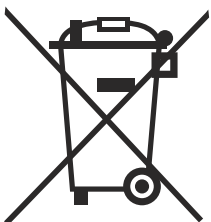

The appliance must not be disposed of with regular household waste. At the end of its service life, the appliance must be properly delivered to a collection point for the recycling of electrical and electronic equipment. By Collection and recycling of old appliances, you are making an important contribution to the conservation of our natural resources and provide for environmentally sound and healthy disposal.



REPLACEMENT PARTS

NO.	DESCRIPTION	PART NUMBER					
		BS2000026-1/EU4 (TRD-26 BESPOKE)	BS2000030-1/EU4 (TRD-30 BESPOKE)	BS2000033-1/EU4 (TRD-33 BESPOKE)	BS2000038-1/EU4 (TRD-38 BESPOKE)	BS2000044-1/EU4 (TRD-44 BESPOKE)	BS2000048-1/EU4 (TRD-48 BESPOKE)
1	Trim			10002566P	10002599P	10002622P	
2	Adjustable Screws			not applicable			
3	Front Glass Bracket			not applicable			
4	Front Glass			60000240	60000243	60000246	
5	Back Glass			60000241	60000244	60000247	
6	Tray Glass			60000242	60000245	60000248	
7	Side Glass			not applicable			
8	Black Glass - Left			not applicable			
9	Black Glass - Right			not applicable			
10	Glass Bracket - Left			not applicable			
11	Glass Bracket - Right			not applicable			
12	Adjustable Leveling Feet			20000979			
13	Flicker Assembly for Flame			20001044	20001047	20001050	
14	Flicker Assembly for Tray			not applicable			
15	Flame Motor			30001868			
16	Heater / Blower Assembly			3000217630002177			
17	LED Light Set for Flames			30002059-33	30002056-38	30002059-44	
18	LED Light Set for Ember Bed /Tray Lighting			3000181230001961-33	30001812-38	30001859-44	
19	LED Light Set for Canopy Lighting			30002170-33	30002171-38	30002171-44	
20	Temperature Sensor			30000511			
21	Remote Signal Receiver			30000701			
22	Remote Control			10105070			
23	Circuit Board			30002180			
24	AC Adapter			30001978			
25	Circuit Board for Touch Panel			200005822000092930001983			
26	Circuit Board for Touch Pad			not applicable			
27	WiFi Card			212051			
28	Bluetooth Speaker Set (Set includes: Power Circuit Board, Speaker Circuit Board & Speaker)			300021183000211930002201			
29	Speaker Set (Set includes: Speaker Circuit Board & Speaker)			3000203230002057-TRD			
30	Power Cord			10103060E(UK) / 10103030E(EUR) / 10103109E(CH) / 10103087F(Aus.)			

EXPLODED VIEW

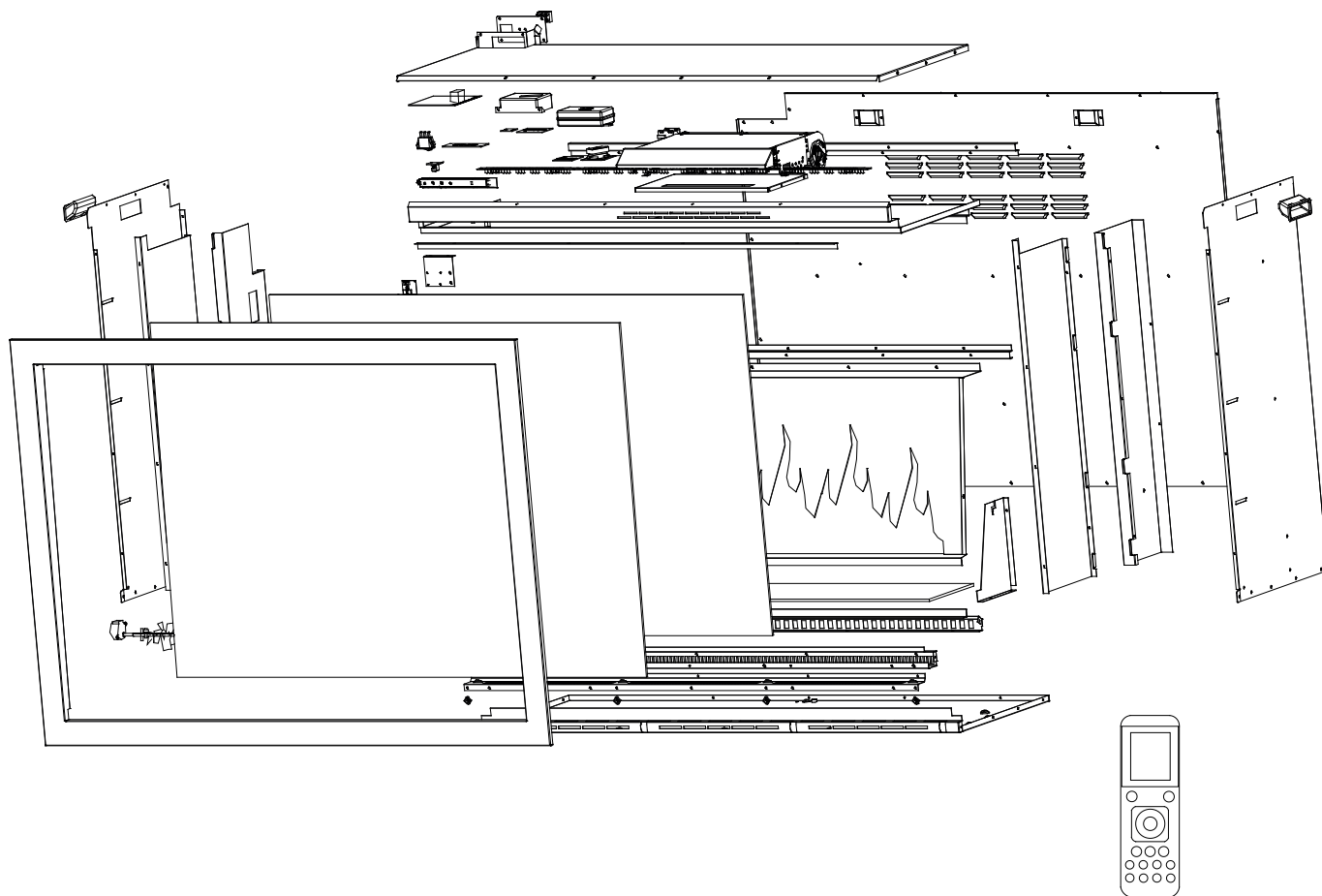

ELECTRIC FIREPLACE WARRANTY

FOR PRODUCTS MANUFACTURED AFTER JANUARY 1, 2016



Amantii Imports Corp. ("Amantii") warrants that your newly purchased Amantii electric fireplace is free from manufacturing and material defects for a period of two (2) years from the date of the first purchase, subject to the conditions and limitations contained below.

WARRANTY APPLICATION & EXCLUSIONS

This limited warranty applies to your newly purchased Amantii electric fireplace; the limited warranty's application is limited to purchases made in any province of Canada or in any of the 50 States of the United States of America, including the District of Columbia. Only the original purchaser of the product is eligible for coverage under this limited warranty; the warranty is not transferable.

PRODUCTS EXCLUDED FROM THIS LIMITED WARRANTY

LED lights are not covered by this limited warranty and are the sole responsibility of the owner/purchaser.

WARRANTY COVERAGE AND TERM

Products covered by this limited warranty have been tested and inspected prior to shipment and, subject to the provisions of this warranty, Amantii warrants such products to be free from defects in material and workmanship for a period of two (2) years from the date of the first purchase of such products.

The limited two (2) year warranty period for products also applies to any implied warranties that may exist under applicable law. Some jurisdictions do not allow limitations on how long an implied warranty lasts, so the above limitation may not apply to the purchaser.

All other warranties—expressed or implied—with respect to the product, its components and accessories or any obligation/liabilities on the part of Amantii are hereby expressly excluded.

WARRANTY COVERAGE AND TERM - BESPOKE SERIES

Products covered by this limited warranty have been tested and inspected prior to shipment and, subject to the provisions of this warranty, Amantii warrants such products to be free from defects in material and workmanship for a period of five (5) years from the date of the first purchase of such products.

The limited five (5) year warranty period for products also applies to any implied warranties that may exist under applicable law. Some jurisdictions do not allow limitations on how long an implied warranty lasts, so the above limitation may not apply to the purchaser.

All other warranties—expressed or implied—with respect to the product, its components and accessories or any obligation/liabilities on the part of Amantii are hereby expressly excluded.

LIMITATIONS TO COVERAGE UNDER LIMITED WARRANTY

This limited warranty does not apply to products that have been repaired, except by Amantii or its authorized service representatives, or otherwise altered. This limited warranty further does not apply to defects resulting from misuse, abuse, accident, neglect, incorrect installation, improper maintenance or handling, or operation with an incorrect power source. Products made by other manufacturers, sold with the product or thereafter, are not covered by this limited warranty. The use of unauthorized components will render this warranty null and void.

PANORAMA OUTDOOR UNITS

All Panorama units that are installed outdoors or in moisture intense conditions must use the stainless steel cover. Proof of purchase of the cover is required for any warranty claims.

SERVICE UNDER LIMITED WARRANTY

Defects must be brought to the attention of Amantii Technical Support by contacting Amantii at (1.877.850.9458), or at 502-1027 Davie Street, Vancouver, BC V6E 4L2. Please have your proof of purchase, catalogue/model and serial numbers available when calling; any and all service under the limited warranty requires a proof of purchase of the product.

DEFECTS

Should a product or part covered by this limited warranty be proven to be defective, in material or workmanship, and during the two (2) year limited warranty period, Amantii will replace such defective product or part without charge. If Amantii is unable to replace such product, or if replacement is not commercially practicable or cannot be timely done, in its sole discretion Amantii may, in lieu of replacement, choose to refund the purchase price for such product or part.

ELECTRIC FIREPLACE WARRANTY

FOR PRODUCTS MANUFACTURED AFTER JANUARY 1, 2016

APPLICATION OF PROVINCIAL AND STATE LAW

This limited warranty gives you specific legal rights, and you may also have other rights which vary from jurisdiction to jurisdiction. The provisions of the United Nations Convention on Contracts for the Sale of Goods shall not apply to this limited warranty or the sale of products covered by this limited warranty.

GENERAL

Amantii reserves the right to make changes at any time without notice, in design, material, specifications, prices and the right to discontinue styles and products.

GLASS

This limited warranty does not apply to the following glass products:

Model Type	Tray Glass	Front Glass	Back Glass
Symmetry / Panorama	✓	✓	✓
Traditional (TRD)	✓	✓	✓
Tru View	✓	✓	✓
Freestand / Inserts	✓	✓	✓
WM - Wall Mount	✓		

EXCLUSION OF BATTERIES

Ocean carriers have set new rules designed to protect the safety of shipments while in transit. This new rule disallows the inclusion of lithium/alkaline batteries, as a result we will no longer be including batteries with the fireplace remote.

REPLACEMENT MOTORS

With the reliability of the components used in the construction of our electric fireplaces, a complimentary replacement motor will no longer be included inside the carton containing the fireplace.

Technical Support: 877.850.9458 - Ext 1

Customer Service: 877.850.9458 - Ext 5

Or email us at: cdn-service@amantii.com

ELECTRIC FIREPLACE